









Smart Wi-Fi Pet Feeder, UltraHD Camera, 4L

TLL331461

-  User manual
-  Manual de utilizzare
-  Manual del usuario
-  Manuel d'utilisation
-  Manuale d'uso
-  Benutzerhandbuch



WORKS WITH
amazon alexa



works with
Google Assistant



works with
Siri Voice



INTO YOUR FUTURE

Thank you for choosing Tellur!

To ensure an optimum performance and safety, please, read this user manual carefully before using the product. Keep this user manual safe for future references.

1. What's in the box

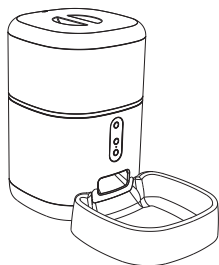

Pet feeder

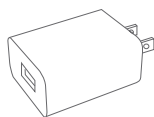

adapter
x 3 (EU/US/UK)



Cable

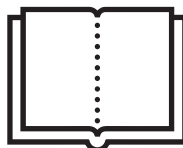

Manual



Desiccant

*Desiccant= Material or substance that has the property of absorbing excess moisture from a given environment.

2. Product diagram

Top cover

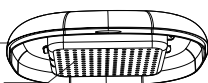

Desiccant box

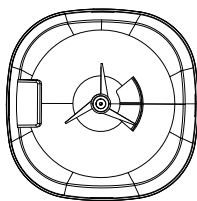

Automatic
feeding device

Grain barrel

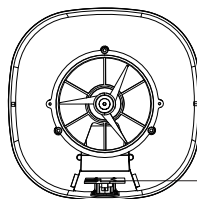
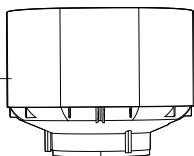

Micro SD slot

Main body

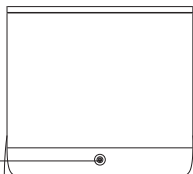

Feeding button

Record button
Play button

Power interface

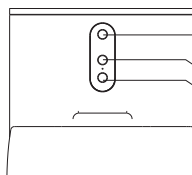

Food bowl

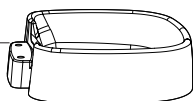

Switch button

Dry battery
compartment

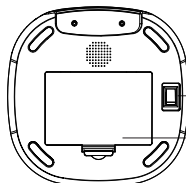

Battery use instructions: When the external power fails, the device will automatically enable the installed battery to power the device. **Note:** The device cannot charge the battery

3. Technical specifications:

Food capacity: 4 liters

Food dimension: 2mm ~ 10mm, dry food

Food portions: Up to 10 portions each feed

Feed record log: Yes

Feeding notification: Yes, push notification via APP

Low food warning: Yes, push notification via APP

Voice recorder: Yes

Scheduled and remote feeding: Yes

Removable container: Yes, for easy cleaning

Power supply: Port Micro USB DC 5V/1A, braided cable

Emergency power supply: 3 x D (LR20) battery (not Included)

Sensor type: 1/2.8" CMOS

Sensor resolution: 3 Megapixels

Lens: f:4mm / F2.0

Field of view: 110°

Infrared sensor: Yes, up to 8 meters

Image resolution: Ultra HD 2304 x 1296

Video compression: H.265

Frame rate: Up to 20/second

Image flip: Vertical by APP

Motion detection: Yes

Night vision: Yes

Audio communication: Two-way audio

Built-in speaker: 1W

Built-in microphone: Yes

Internal storage: MicroSD card up to 128GB Class 10 min (not included)

Cloud storage: Yes, compatible

Google Home: Compatible

Amazon Alexa: Compatible

APP Name: Tellur Smart

APP Pairing Name: Tellur Pet Feeder

Wi-Fi standard: IEEE 802.11b/g/n

Supported Wi-Fi network: 2.4GHz

Suitable for: Indoor use

Working condition temperature: -10°C ~ +55°C

Working condition humidity: 10% ~ 95% RH

Product dimensions: 196 x 355 x 289mm

Product weight: 2000g

Color: White

Important notes and cautionary tips:

- Avoid mounting the device in a place where the temperature changes too much, such as heat/cold sources, air-outlet, etc.
- Please place the device correctly; prevent the pet from tipping over the device. Ideal placement in a corner or against the wall. This device is suitable for small and medium pets under 20kg.
- Replace the desiccant in the storage lid regularly.
- Do not drop any other substances than pet dry food into the grain bin. Otherwise, the device may function abnormally or can cause pet safety problems.
- Regularly clean the food bucket and food bowl.
- The power cable should be installed as concealed as possible to prevent being damaged by the pets.
- Make sure the power plug is firmly connected to the power socket.
- If you smell smoke, or hear high noise, from the device, turn off the power and unplug the power cable. Then contact the service center for assistance.
- Do not touch the camera lens with fingers. If cleaning is necessary, use a clean cloth and wipe it gently.
- The camera sensor may be damaged by laser beams. Make sure the camera will not be exposed to any laser beam.

First use:

1. Open the top cover of the feeder and remove the power cord adapter from the food bucket.
2. Plug the power cord into the power connector on the rear of the main unit and connect the adapter to power.
3. Place the main unit in a vertical position and mount the food bowl at the corresponding position of the main unit.
4. Add pet dry food to the feeder bucket. Compatible with food dimension 2mm~10mm
5. Place the desiccant in the desiccant box by default. Please replace it regularly for long-term use (do not clean)
6. The battery compartment can be installed with 3 x D (LR20) battery (not included) for manual feeding when there is no electricity.
7. Pair with Tellur Smart APP to set up the feeding schedule and use all functions including the camera.

Functions description:

1. Feed button – Short press for one portion release (about 10 grams, depending on the food type). Long press for 5 seconds to restore to factory settings.
2. Record button – Press and hold to record audio message for calling the pet to eat. The message will be played 3 times when feeding is activated.
3. Play button – Plays the recorded audio message.
4. Feeding and low food notification – Notifications will be sent via Tellur Smart APP when food is released or when there is not enough food in the device.
5. Camera functions – motion detection, night vision and two-way audio communication via Tellur Smart APP.
6. Google Home and Amazon Alexa compatible.

Cleaning and maintenance

The food bowl and the bucket should be cleaned regularly to prevent harmful occurrence of bacteria that can affect the health of the pet.

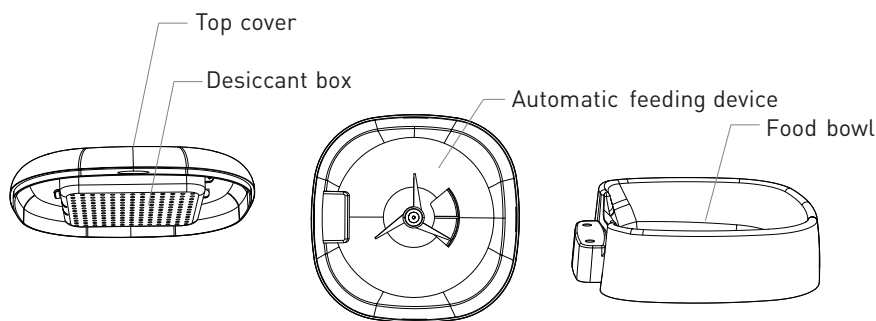

- The upper part of the device and the food bowl can be removed and cleaned with water and detergent.
- Remove the desiccant box before cleaning
- After cleaning, all components must be dried or air-dried before being assembled for use.
- This feeder is suitable for dry foods smaller up to 10 mm size.
- Please keep the environment dry.

5. Pairing the device with Tellur Smart APP

Note

Make sure your phone is connected to the 2.4GHz wireless network and you have access to Wi-Fi password before you start the pairing procedure.

The app doesn't support Wi-Fi 6 networks with 802.11ax standard. Please set the 2.4GHz Wi-Fi network to 802.11b/g/n

We also recommend having the Bluetooth function activated for an easier pairing.

1. Download and install the Tellur Smart app, available for either iOS or Android devices.

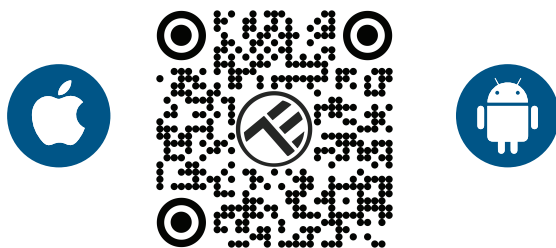

2. Once downloaded, the app will ask you to create an account (if you don't have any already). Enter your email, select the country you live in and create a password for your Tellur Smart account

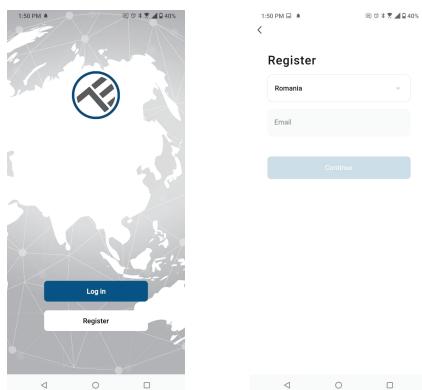

***Set up router

This device only supports 2.4GHz frequency band router, does not support 5GHz frequency band router. Please set the relevant parameters of the router before Wi-Fi configuration, Wi-Fi passwords do not include special characters such as ~!@#\$%^&*(). When the device is being connected to the Wi-Fi, keep the mobile phone and device close to the router to speed up the configuration of the device.

1. Open the Tellur Smart app and click “Add device” or “+” and then select “Video Surveillance” -> “Pet Feeder with Camera (Wi-Fi)”.

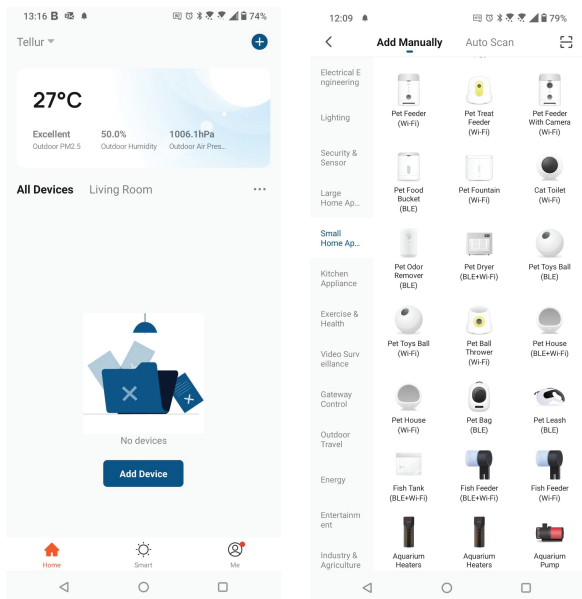

2. When connecting, make sure your router, smartphone and the device are as close as possible.

3. Power on and reset the device until the status indicator is flashing quickly or a prompt tone is heard, and then click "Next". Then input your Wi-Fi password and click "Next".

Click  to change network if necessary

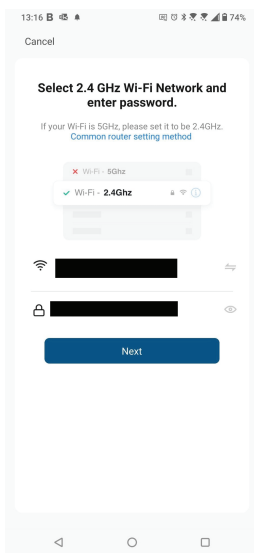
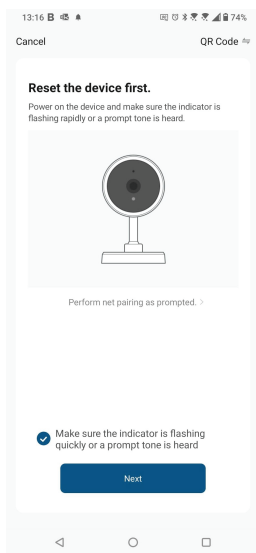

4. With the camera lens, scan the QR code that appeared on your phone. When the device makes a sound, click “I heard a Prompt” and the configuration will be complete.

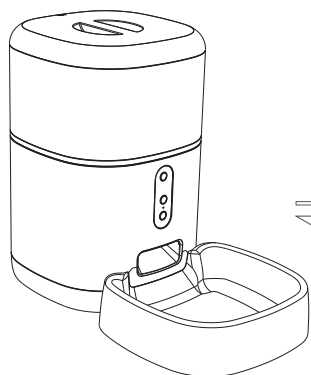

20 30cm

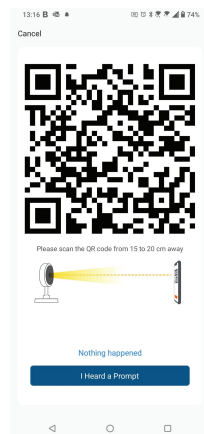

6. Storage

Installing microSD card

1. The storage card slot is located inside the food bucket as seen in the diagram below.
2. Insert the card in the slot
(The camera supports microSD cards up to 128GB capacity, minimum class 10 required.)

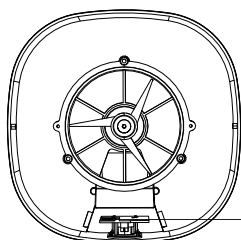

MicroSD card slot

Formatting the card

1. Access the live view
2. Go to settings menu (click on “...” from top right corner)
3. Select Card Settings. Here you can see how much capacity is used and available.
4. Choose Format Card

Recording settings

1. Ensure you have inserted a compatible microSD card and its formatted.
2. Access the camera and go to settings menu (click on “...”) and choose Card Settings
3. Click on Recording Mode and you can select Continuous recording or Event recording

7. Failed to add device?

- Make sure the device is powered on.
- Check the Wi-Fi connection of your phone.
- Check if the device is in pairing mode. Reset your smart device to enter pairing mode.
- Check router or related: If you use a dual-band router, select the 2.4GHz network to add the device. You also need to enable the router's broadcasting function. Set encryption method as WPA2-PSK and authorization type as AES or set both on "auto".
- Check if the Wi-Fi signal is strong enough. To maintain the signal strong, keep your router and the smart device as close as possible.
- Wireless mode should be 802.11.b/g/n (Wi-Fi 6 protocol 802.11ax is not supported)
- Make sure you don't exceed the maximum number of registered devices supported by the app (150).
- Check if the router's MAC filtering function is enabled. If so, remove the device from the filter list and make sure the router is not prohibiting the device connection.
- Make sure the Wi-Fi password entered in the app is correct.

Can I control the device with 2G/3G/4G network?

When adding the device for the first time, the device and the phone need to be connected to the same Wi-Fi network. Once the device has been successfully paired with the Tellur Smart app, you can remotely control it via 2G/3G/4G networks.

How can I share my device with family?

Open Tellur Smart app, go to "Profile" -> "Device sharing" -> "Sharing sent", tap "Add sharing" and share the device with the added family members.

Notice - users must install the Tellur Smart app on their device in order to see shared devices.

How can I manage the devices shared by others?

Open App, go to "Profile" > "Device Sharing" > "Sharing Received", then you can find the devices shared by other users. To delete a shared device, swipe left.

8.Alexa integration

1. Go to Home menu on Alexa app.
2. Select "Skills" / "Skills & Games".
3. Type Tellur Smart in the search bar.
4. Select Tellur Smart and click "Enable" to activate Tellur Smart.
5. Enter your Tellur Smart account and password. Now you have finished the integration with Alexa.

Tellur Smart app is now skilled with Alexa, and you can vocally control the devices added in Tellur Smart.

Remember - if you rename your smart devices, use a simple name that Alexa can recognize.

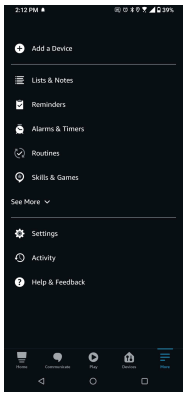

1.

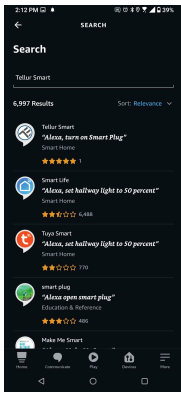

2.

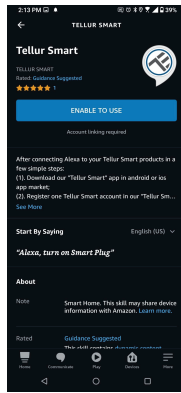

3.

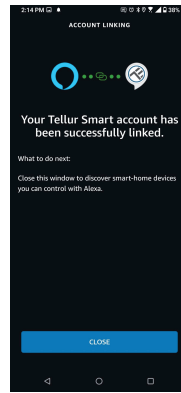

4.

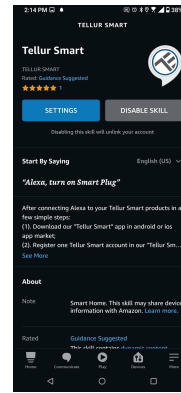

5.

To control your smart devices through Alexa, use simple and concise voice commands. Here is an example for bedroom lighting:

- “Alexa, turn off bedroom light”
- “Alexa, turn on bedroom light”
- “Alexa, dim bedroom light”
- “Alexa, set bedroom light to red”

9. Google Home integration

Before using Google Home to control your devices, make sure you meet the following conditions:

- You have a Google Home device or an Android device with Google Assistant.
- You have the newest version of Google Home app.
- You have the newest version of Google app (Android only).
- The device display language is set to English US.
- You have the Tellur Smart app and a related account.

Add devices in Tellur Smart app (refer to app instructions) – you can skip this part if you have already added some devices to your Tellur Smart account. Make sure your devices' names are easily recognizable.

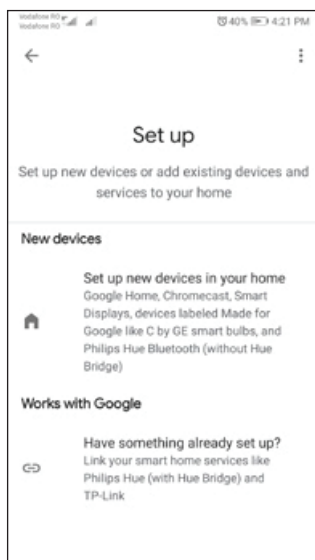
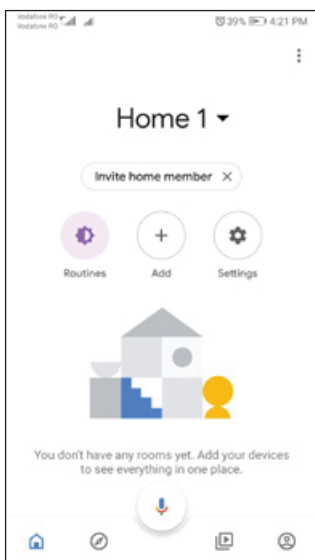

2. Hit the "Add new" button, enter Tellur Smart in the search bar, and select the app from the list. Next, select your Tellur Smart account's region, enter your Tellur Smart account and password, and tap "Link now". After you assign rooms for devices, your devices will be listed in the Home Control page.

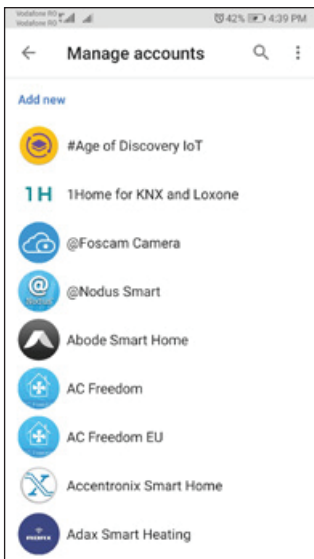

Now you can control your smart devices through Google Home. Take bedroom light as example – the supported voice commands are as below:

- Ok Google, turn on/off bedroom light.
- Ok Google, set bedroom light to 50 percent.
- Ok Google, brighten bedroom light.
- Ok Google, dim bedroom light.
- Ok Google, set bedroom light to red.

Disposal and recycling information



The crossed-out wheeled-bin symbol on your product, battery, literature or packaging reminds you that all electronic products and batteries must be taken to separate waste collection points at the end of their working lives; they must not be disposed of in the normal waste stream with household garbage. It is the responsibility of the user to dispose of the equipment using a designated collection point or service for separate recycling of electrical and electronic equipment waste (WEEE) and batteries according to local laws. Proper collection and recycling of your equipment helps ensure EEE waste is recycled in a manner that conserves valuable materials and protects human health and the environment. Improper handling, accidental breakage, damage, and/or improper recycling at the end of its life may be harmful for health and environment.